

TOLX18

1.

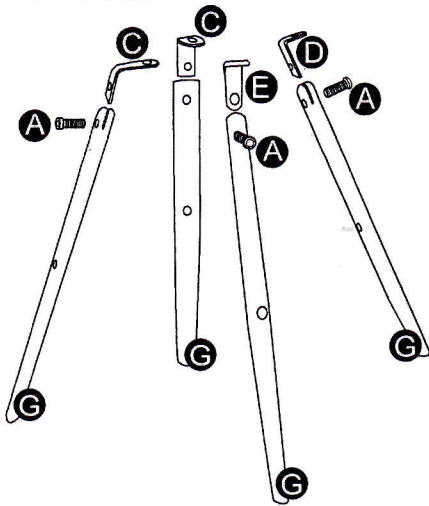

2.

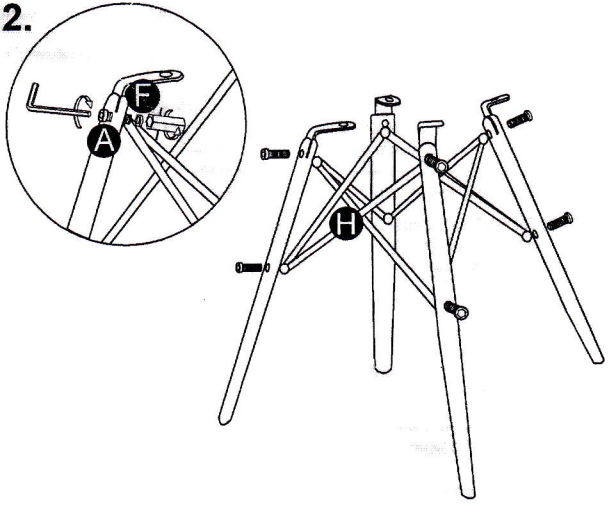

3.

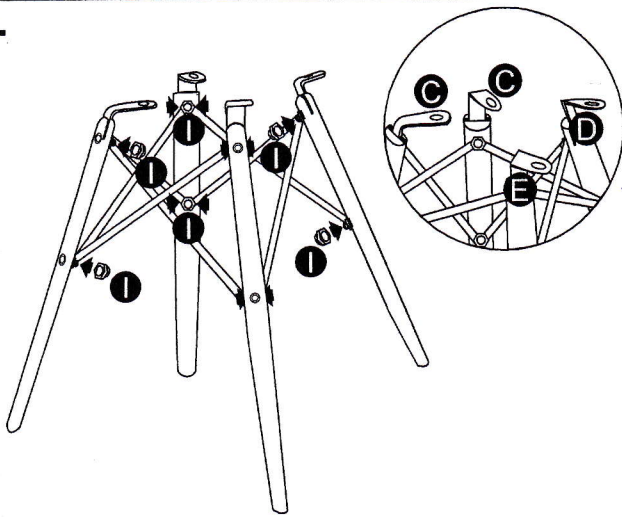

4.

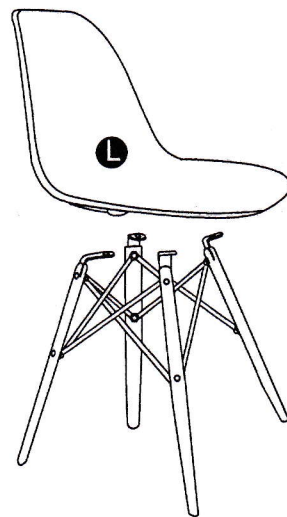



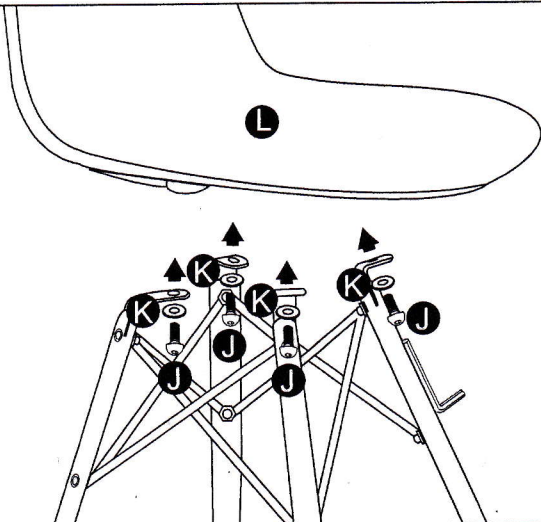



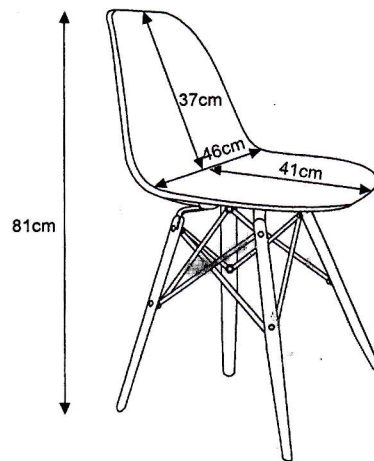

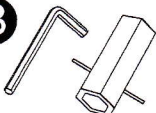
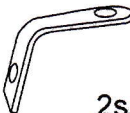
5.

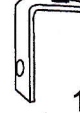

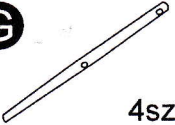
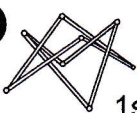
6.



A  8szt	B  1szt	C  2szt	D  1szt	E  1szt	F  8szt
G  4szt	H  1szt	I  8szt	J  4szt	K  4szt	L  1szt